

Kit 1050

VOLKSWAGEN Golf IV, 3-dr Hatchback, 98-03 / *99-05

VOLKSWAGEN GTI IV, 3-dr Hatchback, *99-06

VOLKSWAGEN Jetta IV, 3-dr Sedan, 98-04

*North America

480R
754

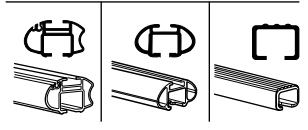
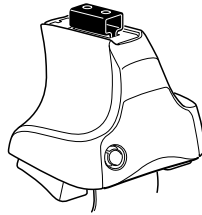

480

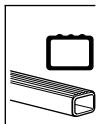
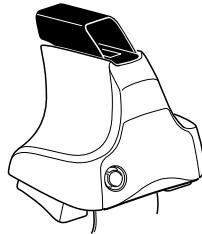

750

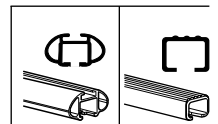
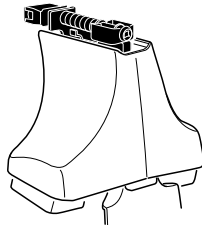

Kit



3

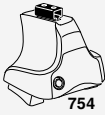

754

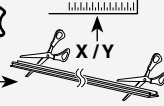

x/y

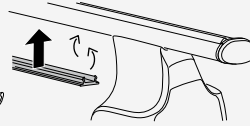

750



1

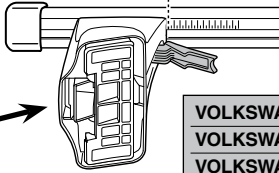
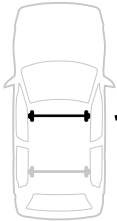

2

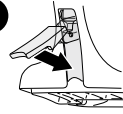

	X
VOLKSWAGEN Golf IV, 3-dr Hatchback, 98-03 / *99-05	27
VOLKSWAGEN GTI IV, 3-dr Hatchback, *99-06	27
VOLKSWAGEN Jetta IV, 3-dr Sedan, 98-04	27

1

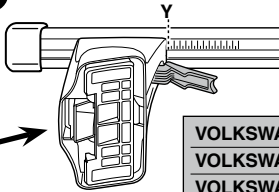

2

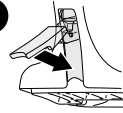

	Y
VOLKSWAGEN Golf IV, 3-dr Hatchback, 98-03 / *99-05	32
VOLKSWAGEN GTI IV, 3-dr Hatchback, *99-06	32
VOLKSWAGEN Jetta IV, 3-dr Sedan, 98-04	32



480R



480

1

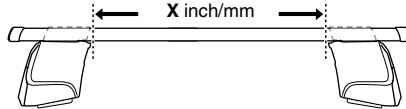
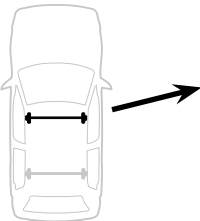

2

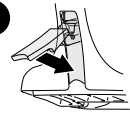

	X inch	X mm
VOLKSWAGEN Golf IV, 3-dr Hatchback, 98-03 / *99-05	36 1/4"	921 mm
VOLKSWAGEN GTI IV, 3-dr Hatchback, *99-06	36 1/4"	921 mm
VOLKSWAGEN Jetta IV, 3-dr Sedan, 98-04	36 1/4"	921 mm

1

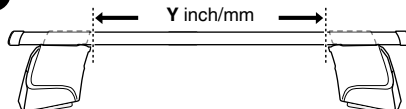
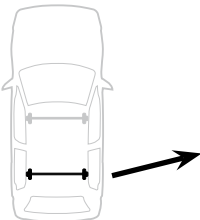

2

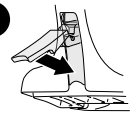

	Y inch	Y mm
VOLKSWAGEN Golf IV, 3-dr Hatchback, 98-03 / *99-05	38 1/4"	971 mm
VOLKSWAGEN GTI IV, 3-dr Hatchback, *99-06	38 1/4"	971 mm
VOLKSWAGEN Jetta IV, 3-dr Sedan, 98-04	38 1/4"	971 mm

4

VOLKSWAGEN Golf IV, 3-dr Hatchback, 98-03 / *99-05

VOLKSWAGEN GTI IV, 3-dr Hatchback, *99-06

VOLKSWAGEN Jetta IV, 3-dr Sedan, 98-04

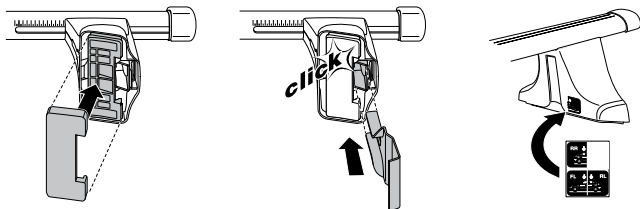
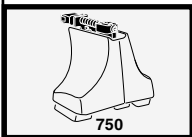
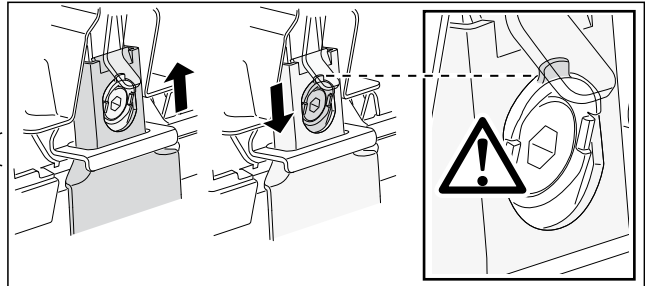
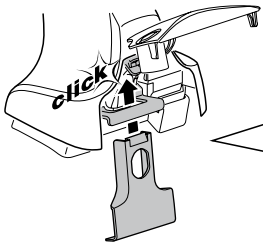
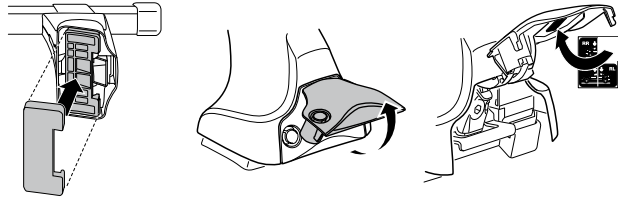
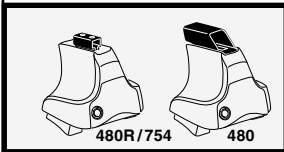
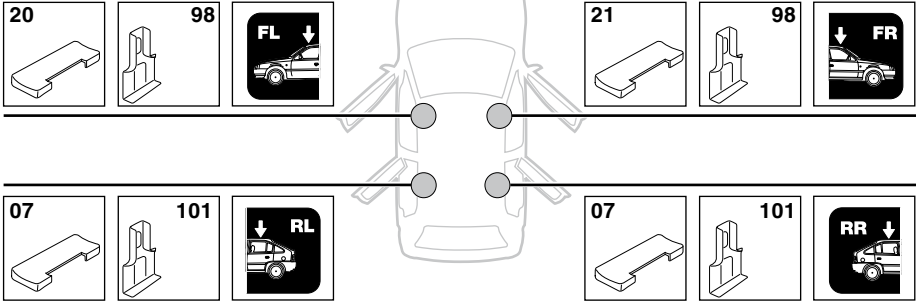

5

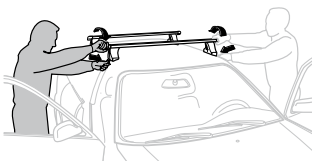
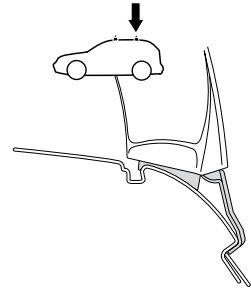
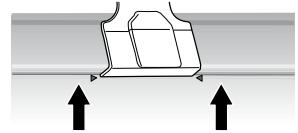
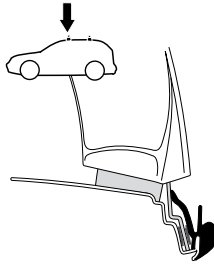
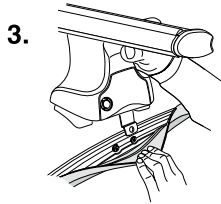
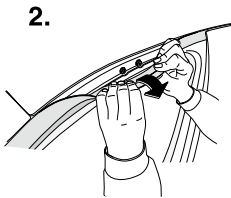
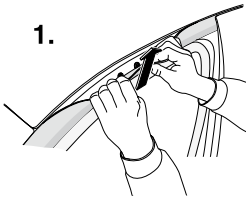
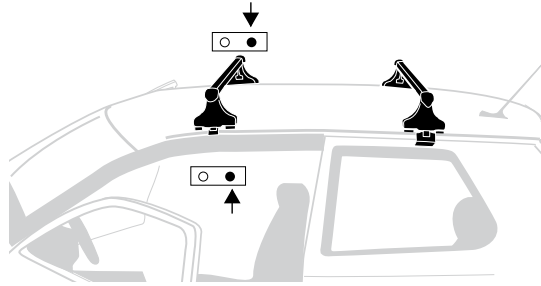
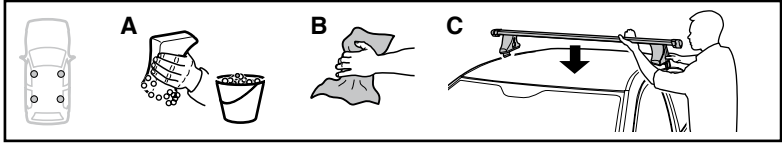

GB/US Tighten alternately
D Die Schrauben abwechselnd anziehen
F Serrer alternativement chaque côté
NL Afwisselend aan de linker- en de rechterkant aandraaien
I Alternare il serraggio delle viti
E Apretar alternativamente
PT Aperte alternadamente
S Dra åt växelvis
FIN Kierrä vuorotellen
EST Pinguldage vaheldumisi
LAT Pievelciet pamišus
LIT Užsukinėkite pakaitomis
PL Śruby dokręcaj naprzemiennie
RU Затягивайте попеременно

CZ Pokręťta bagazníka dokręcaj dokręcaj naprzemiennie.
SK Dofahujte striedavo.
SLO Privijajte izmenično.
HR Naizmjenično zategnite
HU Egymástól függetlenül szorítandó
GR Σφιγίγτε εναλλάξ
TR Dönüşümüü sıkın

中文 交替拧紧

한국어 번갈아 가며 조이십시오.

日本語 交互に締め付けてください。

ไทย ชั้้นในแบบสลับ

6



480R/754



480

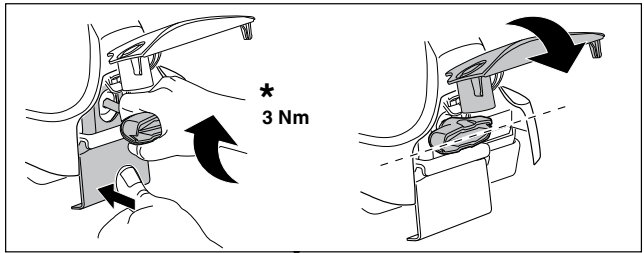

*
3 Nm



*



*
≈ 3 Nm

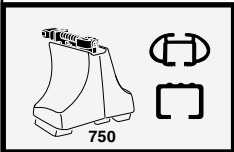
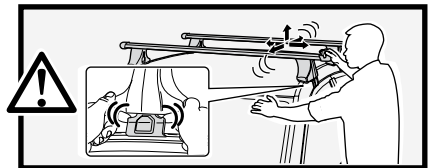

750

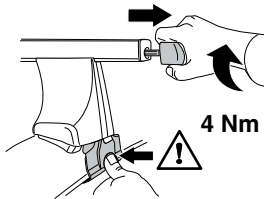

4 Nm

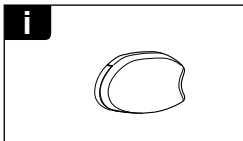
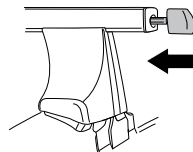

i

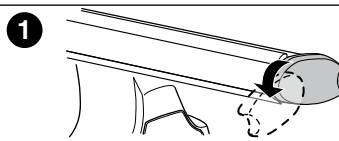

1

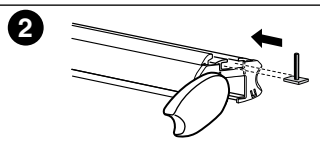

2

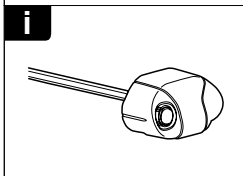

i

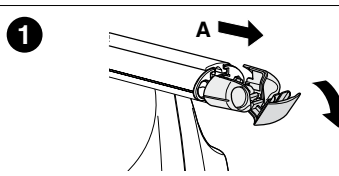

1

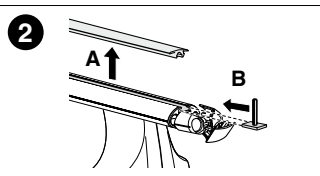

2

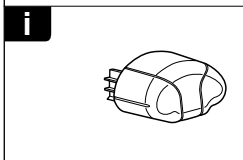

i

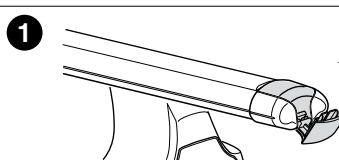

1

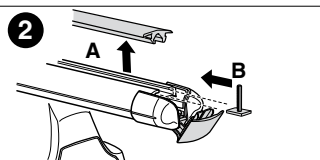

2

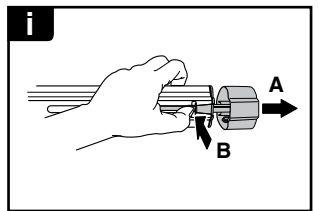
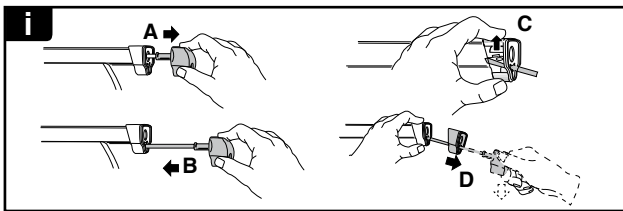
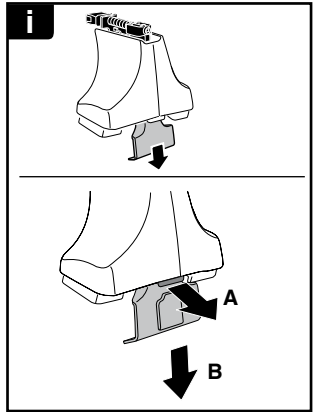
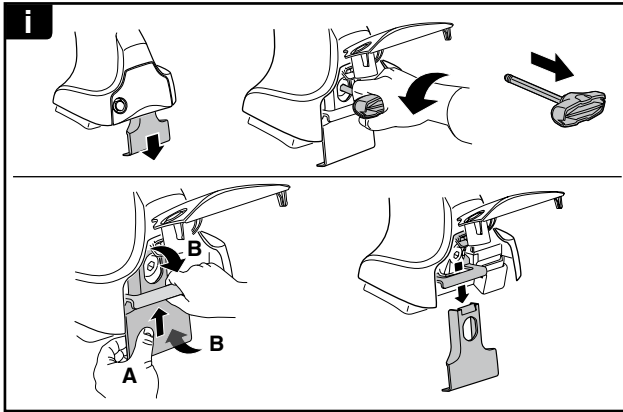

THULE
SWEDEN
**ONE
KEY
SYSTEM**

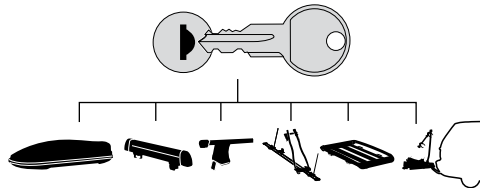

		544	(x4)
		596	(x6)
		588	(x8)
NA		510	(x10)
EUR		452	(x12)
ASIA			

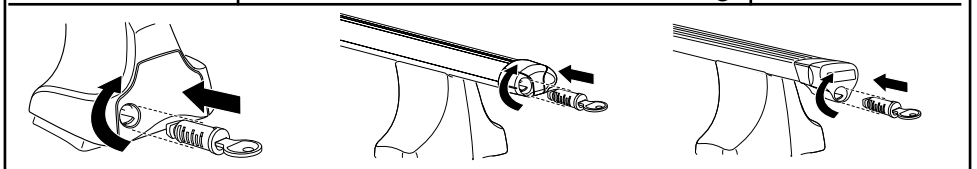

WW ▶ Thule Sweden AB, Box 69, 330 33 Hillerstorp, SWEDEN
NA ▶ Thule Inc., 42 Silvermine Road, Seymour, Connecticut 06483, USA

info@thule.com
customer.service@thule.com

www.thule.com