

Kit 1064

TOYOTA HiLux Surf, 5-dr SUV, 96-03

TOYOTA Tacoma, 4-dr Quad Cab, *96-04

TOYOTA 4 Runner, 5-dr SUV, 96-03 / *96-02

*North America

480R
754

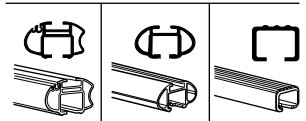
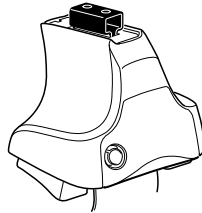

480

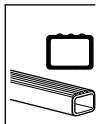
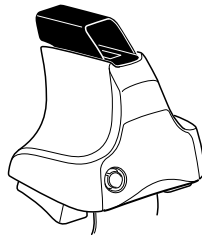

750

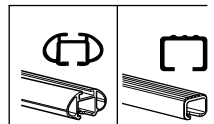
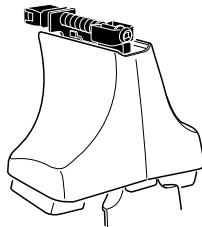

x2 x2 x2 x4	x2	x2 x2 x4 x4	x2 x2	x2

168 x 4

07 x 4

x 1

Kit



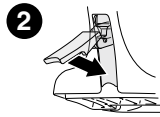
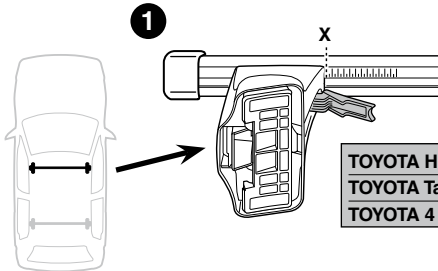

	X
TOYOTA HiLux Surf, 5-dr SUV, 96-03	32,5
TOYOTA Tacoma, 4-dr Quad Cab, *96-04	32,5
TOYOTA 4 Runner, 5-dr SUV, 96-03 / *96-02	32,5

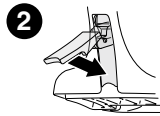
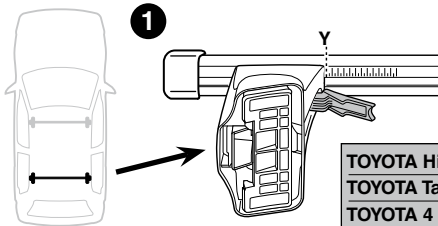

	Y
TOYOTA HiLux Surf, 5-dr SUV, 96-03	32,5
TOYOTA Tacoma, 4-dr Quad Cab, *96-04	32,5
TOYOTA 4 Runner, 5-dr SUV, 96-03 / *96-02	32,5

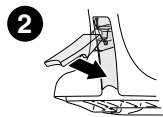
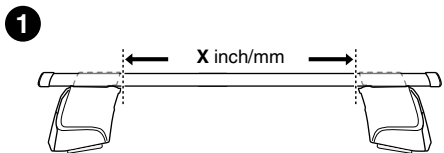
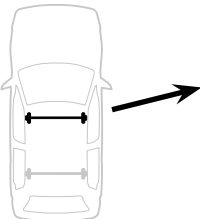
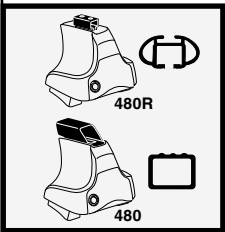

	X inch	X mm
TOYOTA HiLux Surf, 5-dr SUV, 96-03	38 3/8"	976 mm
TOYOTA Tacoma, 4-dr Quad Cab, *96-04	38 3/8"	976 mm
TOYOTA 4 Runner, 5-dr SUV, 96-03 / *96-02	38 3/8"	976 mm

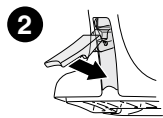
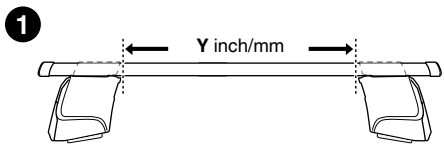
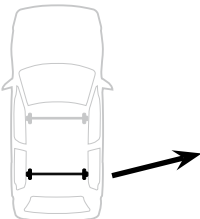

	Y inch	Y mm
TOYOTA HiLux Surf, 5-dr SUV, 96-03	38 3/8"	976 mm
TOYOTA Tacoma, 4-dr Quad Cab, *96-04	38 3/8"	976 mm
TOYOTA 4 Runner, 5-dr SUV, 96-03 / *96-02	38 3/8"	976 mm

4

TOYOTA HiLux Surf, 5-dr SUV, 96-03

TOYOTA Tacoma, 4-dr Quad Cab, *96-04

TOYOTA 4 Runner, 5-dr SUV, 96-03 / *96-02

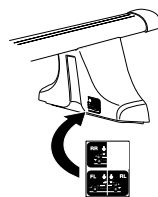
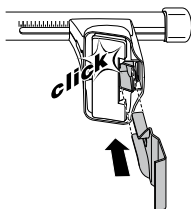
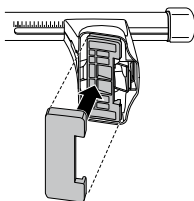
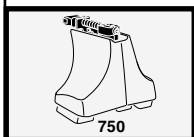
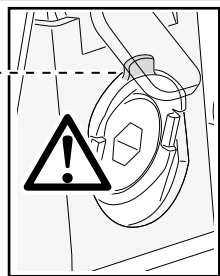
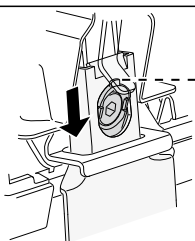
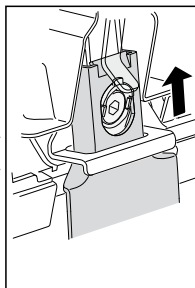
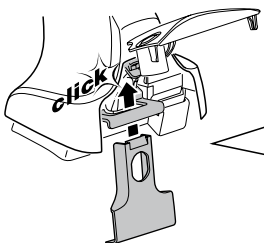
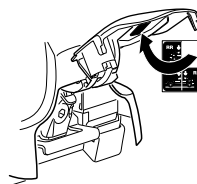
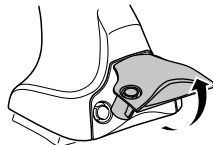
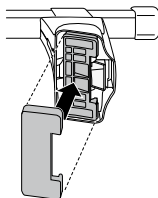
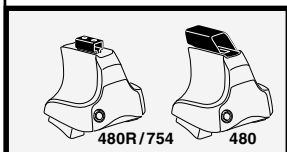
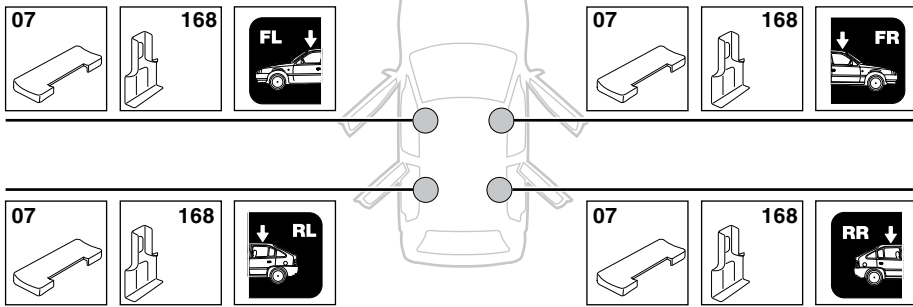

5



	X mm	Y mm	X inch	Y inch
TOYOTA HiLux Surf, 5-dr SUV, 96-03	270 mm	700 mm	10 5/8"	27 1/2"
TOYOTA Tacoma, 4-dr Quad Cab, *96-04	270 mm	700 mm	10 5/8"	27 1/2"
TOYOTA 4 Runner, 5-dr SUV, 96-03 / *96-02	270 mm	700 mm	10 5/8"	27 1/2"

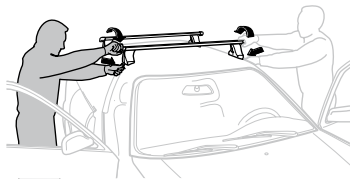
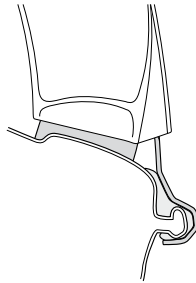
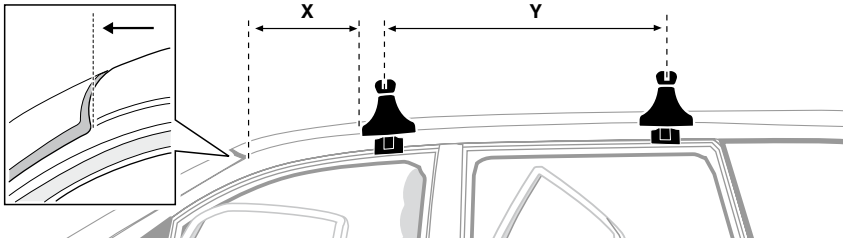

GB/US Tighten alternately

D Die Schrauben abwechselnd anziehen

F Serrer alternativement chaque côté

NL Afwisselend aan de linker- en de rechterkant aandraaien

I Alternare il serraggio delle viti

E Serrare alternativamente

PT Aperte alternadamente

S Dra åt växelvis

FIN Kierrä vuorotellen

EST Pinguldage vaheldumisi

LAT Pielvelciet pamīšus

LIT Užsukinėkite pakaitomis

PL Śruby dokręcaj naprzemiennie

RU Затягивайте попеременно

CZ Pokręťta bagażníka dokręcaj dokręcaj naprzemiennie.

SK Doťahujte striedavo

SLO Privijajte izmenično.

HR Naizmjenično zategnite

HU Egymástól függetlenül szorítandó

GR Σφίγγετε εναλλάξ

TR Dönüşümlü sıkın

中文 交替拧紧

한국어 번갈아 가며 조이십시오.

日本語 交互に締め付けてください。

ไทย ชั้ไนแบบสลับ

6



480R/754



480

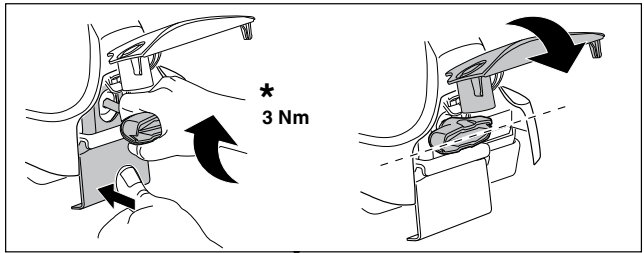

*
3 Nm



*



*
≈ 3 Nm

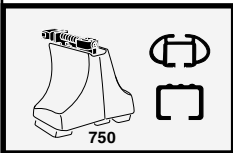
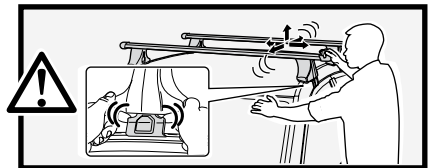

750

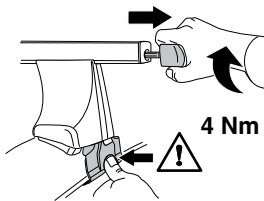

4 Nm

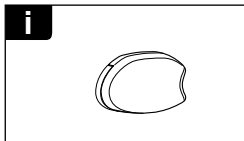
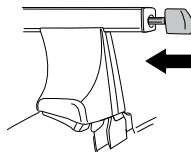

i

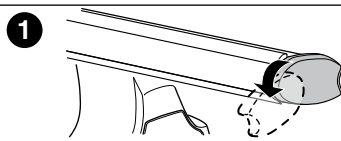

1

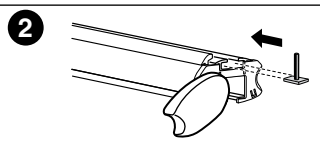

2

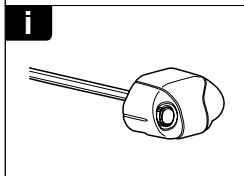

i

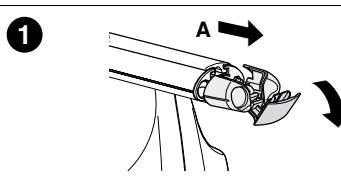

1

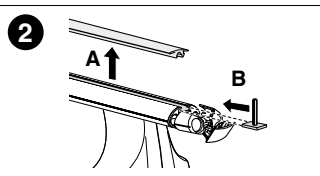

2

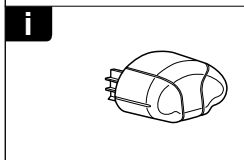

i

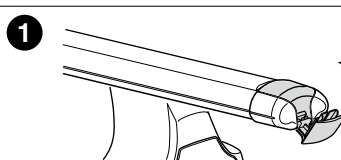

1

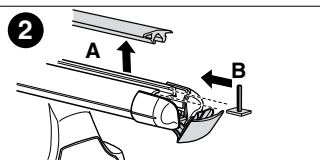

2



THULE
SWEDEN
**ONE
KEY
SYSTEM**

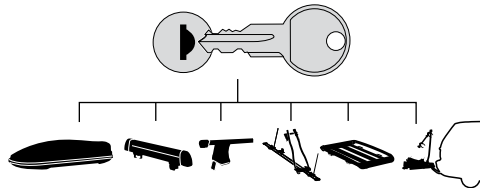

- 544 (x4)
- 596 (x6)
- 588 (x8)
- NA 510 (x10)
- EUR 452 (x12)
- ASIA



WW ▶ Thule Sweden AB, Box 69, 330 33 Hillerstorp, SWEDEN
NA ▶ Thule Inc., 42 Silvermine Road, Seymour, Connecticut 06483, USA

info@thule.com
customer.service@thule.com

www.thule.com